



MICKEY

TECHNISCHES BLATT
SCHEMA TECNICA
DATA SHEET
FICHE TECHNIQUE

MICKEY

DESIGN INDIA MAHDAVI, 2023



Liegestuhl aus gebogenem Buchenholz. Gepolsterter Sitz und Rückenlehne mit Polyurethan unterschiedlicher Dichte schaumfüllung.

Poltrona lounge con struttura in faggio curvato. Seduta e schienale in poliuretano espanso a densità differenziate e fibra poliestere.

Bent beech-wood lounge chair. Upholstered seat and backrest with different density polyurethane foam filling.

Fauteuil en bois de hêtre courbé. Siège et dossier rembourrés avec de la mousse polyuréthane de différentes densités.

Silla de salón de madera de haya curvada. Asiento y respaldo tapizados con espuma de poliuretano de diferentes densidades.



PLMICKTES

Dimensions mm.
height 1210 | width 980 | depth 840

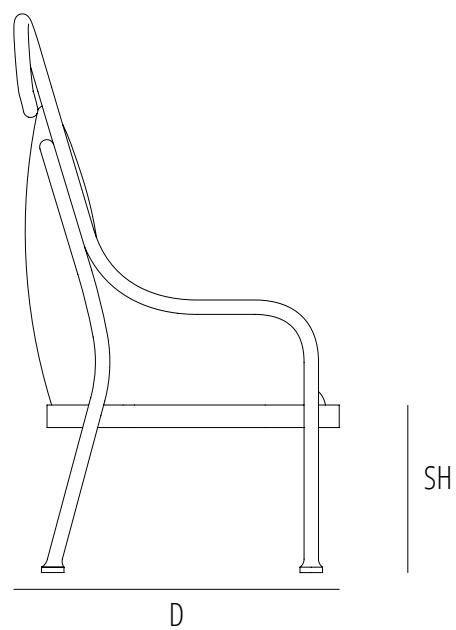
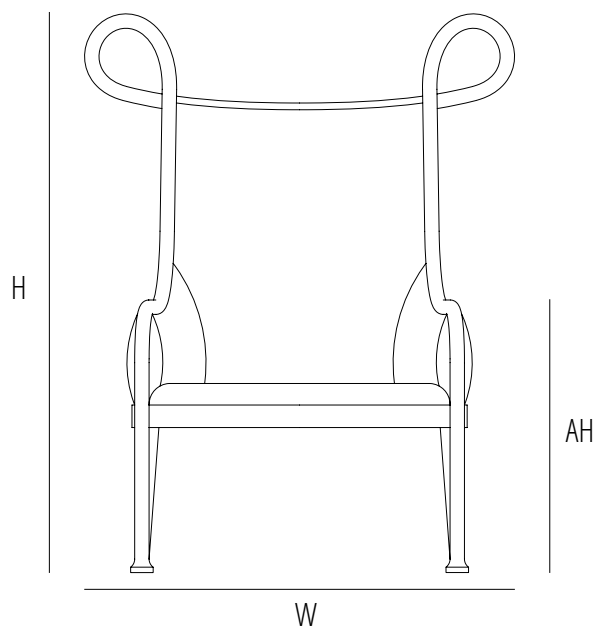

	H	W	D	SH	AH	
mm	1210	980	840	390	610	1 Pz/Pc: 3mt. Linear x 140 cm h/width
inch	47,6	38,5	33	15,3	24	2 Pz/Pc: 6mt. Linear x 140 cm h/width

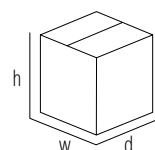
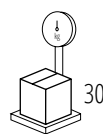
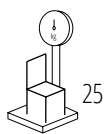
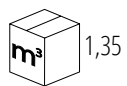
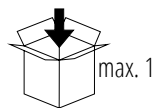

mm - inch
h 1350 - 53,1
w 1000 - 39,3
d 1000 - 39,3

Verfuegbare Ausfuehrungen
Finiture disponibili
Available finishes
Finitions disponibles

SOLID WOOD / ESSENZE NATURALI



B01 BEECH
B01 FAGGIO

CLASSIC LACQUER / LACCATO CLASSICO

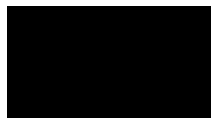

C01 - RAL 9005 BLACK

Gebrüder Thonet Vienna GmbH
Prinz Eugen Straße 42
1040 Wien (AT)

www.gebruederthonetvienna.com

Offices of the trademarks' licensee
Production Furniture International S.p.A.
Via Foggia, 23/H
10152 Torino (TO) Italy

Phone: 0039 011 0133330 - info@gebruederthonetvienna.com